



Technical Data / Fiche Technique / Technische Daten / Datos Técnicos
 Helicopter Crash Kit Box ■ Coffre pour kit accident d'hélicoptère ■ Hubschrauber Notfall-Box ■ Caja de Kit Accidente de Helicóptero

JBB80P-COOR



JBB80P-COOR









Features/Caractéristiques/Merkmale/Características

Helicopter Crash Kit Box (Crash equipment not supplied) • Ideal for heliport rescue equipment (ICAO Annex 14 Vol II - Heliport Manual 6.9) • Plastic toggles, lynch pins and hinge pins as standard • Stainless steel handles for easy handling • Fully recyclable, chemical resistant, UV-stabilized PE • Available in International Orange only • Optional extra: Logo service on request - all logos will be laser engraved as standard.

Hubschrauber Notfall-Box (Notfall-Set nicht enthalten) • ideal für Heliport-Rettungsausrüstung nach Richtlinie ICAO Annex 14 Vol. II (Heliport Handbuch 6.9) • mit Verschlussbügel, Sicherungssplint und Scharnieren aus Kunststoff • Edelstahlgriffe für einfache Handhabung • vollständig recycelbares, chemikalienbeständiges, UV-stabiles PE • Nur in Leucht-orange lieferbar • Extra: Kundenlogo auf Wunsch - Lasergravur als Standard.

Coffre pour kit d'intervention (équipement de sauvetage non fourni) • Idéal pour équipement de sauvetage sur hélicoptère • Fermetures, charnières et goupilles de sécurité plastique avec chaque coffre • Poignées inox pour faciliter la manipulation • En PE entièrement recyclable, résistant à la plupart des produits chimiques et aux UV • Disponible en orange standard uniquement • En option: Plaque de logo sur demande - Tout logo sera gravé au laser.

Caja de Kit Accidente de Helicóptero (Equipamientos salvavidas no suministrados) • Idóneo para equipamientos de salvavidas helipuerto según ICAO Anexo 14 Tomo 11 - Libro Helipuerto 6.9 • Cierres de plástico, pasadores de seguridad y bisagras como estándar • Asas de acero inoxidable para facilitar el manejo • Fabricada en PE 100% reciclable, resistente a la mayoría de los químicos y estabilizada contra los rayos UV • Disponible en color naranja internacional solamente • Extra Opcional: Placa de logotipo a petición - Todos los logos serán gravados con láser como estándar.

	 EAN-13	 mm	 mm	 mm	 mm	 mm	 mm	(E) mm	(F) mm	 kg	
JBB80P-COOR	5055644211379	400	500	720	800	410	480	710	380	10	138



Technical Data / Fiche Technique / Technische Daten / Datos Técnicos
 Helicopter Crash Kit Box ■ Coffre pour kit accident d'hélicoptère ■ Hubschrauber Notfall-Box ■ Caja de
 Kit Accidente de Helicóptero

JBB80P-COOR



**PALLETISATION ♦ PALETTISATION ♦
 PALETTIERUNG ♦ PALETIZACIÓN**

12 units per pallet
 12 pièces par palette
 12 Teile pro Palette
 12 piezas por palé

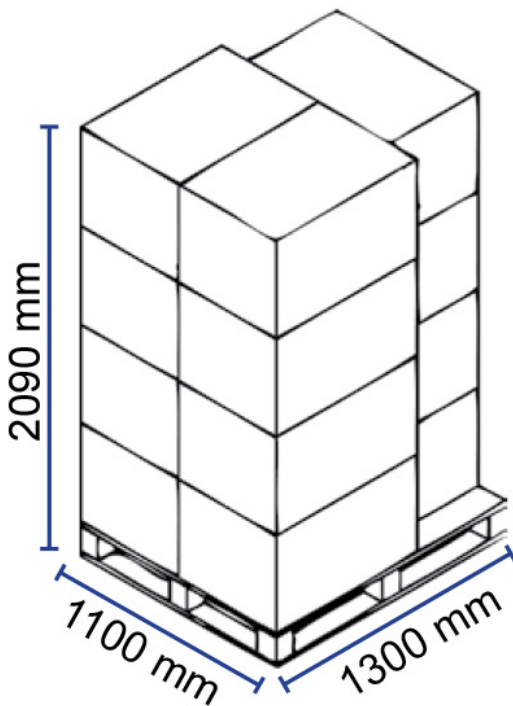

Jonesco (Preston) Ltd.
 Pittman Way
 Fulwood
 Preston PR2 9ZD
 England
 Tel: +44 (0) 1772 704488
 Fax: +44 (0) 1772 702209

Jonesco S.A.R.L.
 SECLIN UNEXPO
 1524 Avenue de l'Épinette
 59113 Seclin
 France
 Tel: +33 (0) 3 20 32 1111
 Fax: +33 (0) 3 20 90 6210
 SARL au capital de 8,000 euros



www.jonesco-plastics.com