



## Technical Data / Fiche Technique / Technische Daten / Datos Técnicos

Spill Pallets ■ Palettes de rétention ■ Auffangwannen ■ Palets para derrames

# SJ-100-025















### Features/Caractéristiques/Merkmale/Características

Spill pallet for 2 drums ■ Heavy duty spill pallet (36.5 kg) for substantial loads ■ Designed to take uniformly distributed load of 2000 kg ■ Blue as standard ■ Durable, removable platform ■ Platform with hand inserts and holes for inspection & pump insertion ■ Capacity meets/exceeds European, UK and US regulations ■ For static spill containment ■ Remove drum before fork lifting ■ Compatible with most forklifts and pallet trucks ■ Fully recyclable, chemical resistant, UV-stabilised PE.

Palette de rétention pour stocker 2 fûts ■ Palette de rétention renforcée (36.5kg) spéciale charges lourdes ■ Conçue pour supporter uniformément une charge de 2000 kgs ■ Couleur standard bleue ■ plate-forme amovible durable ■ Caillebotis avec regards d'inspection et ouvertures pour mains et pompes ■ Capacité conforme ou supérieure aux réglementations Européennes, GB & US ■ Usage statique uniquement ■ Retirer le(s) fût avant manutention ■ Manipulable avec la plupart des chariots élévateurs et transpalettes ■ PE entièrement recyclable, résistant à la plupart des produits chimiques et aux UV.

Auffangwanne für 2 Fässer ■ robuste Auffangwanne (36.5 kg) für schwere Lasten ■ für gleichmäßig verteilte Last von 2000 kg ausgelegt ■ Standardfarbe: Blau ■ robuste, abnehmbare PE-Lochplatte ■ Lochplatte mit Kontrollöffnungen & Aussparungen für Pumpen/Handhabung ■ Auffangvolumen erfüllt/übertrifft europäische, britische und US-Vorschriften ■ für den stationären Gebrauch ■ vor Transport mit Stapler Fässer entfernen ■ für die meisten Stapler/Handhubwagen geeignet ■ vollständig recycelbares, chemikalienbeständiges, UV-stabiles MDPE.

Palet de derrames para 2 bidones ■ Cubeto de retención (36,5 kgs) para cargas pesadas ■ Diseñado para una carga uniformemente distribuida de 2,000 kgs ■ Color azul como estándar ■ Con rejilla extraíble robusta ■ Plataforma con acceso para los manos y agujeros para inspección y para la inserción de bombas ■ Capacidad en línea o por encima de las normas Europeas, Británicas y Americanas ■ Ideales para carga estática ■ Quite los bidones antes de utilizar una carretilla elevadora ■ Para usar con la mayoría de carretillas elevadoras y transpaletas ■ PE 100% reciclable resistente a los rayos UV.

|            |  mm |  mm |  mm |  kg |  |  mm |  |  |  |  mm |  kg |
|------------|--|--|--|--|---|--|--|---|---|--|--|
| SJ-100-025 | 440  | 1300   | 750  | 36.5   |  | 630 x 1180 x 55  |  | 250   | 2   | 190 / 815  | 2000   |



FM12422

**Jonesco (Preston) Ltd.**  
Pittman Way  
Fulwood  
Preston PR2 9ZD  
England  
Tel: +44 (0) 1772 704488  
Fax: +44 (0) 1772 702209

**Jonesco S.A.R.L.**  
SECLIN UNEXPO  
1524 Avenue de l'Épinette  
59113 Seclin  
France  
Tel: +33 (0) 3 20 32 1111  
Fax: +33 (0) 3 20 90 6210  
SARL au capital de 8,000 euros



www.jonesco-plastics.com



**Technical Data / Fiche Technique / Technische Daten / Datos Técnicos**

Spill Pallets ■ Palettes de rétention ■ Auffangwannen ■ Palets para derrames

**SJ-100-025**

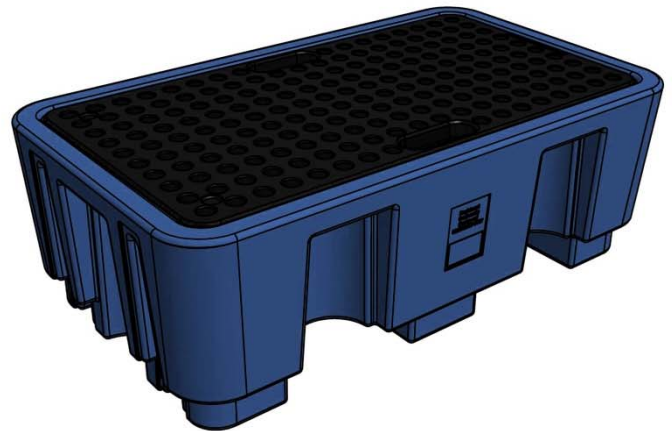
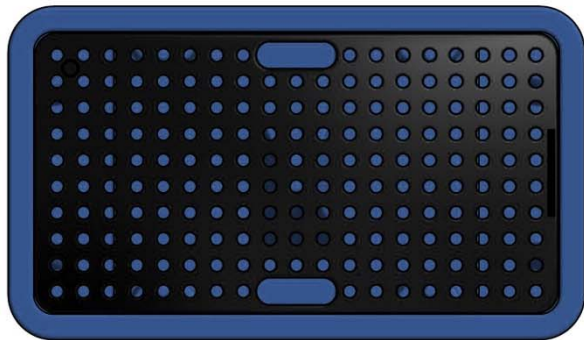
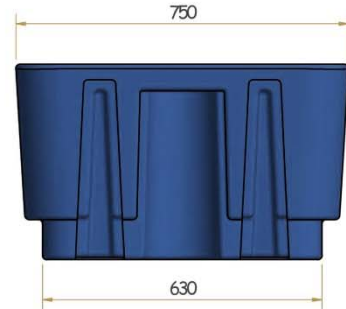
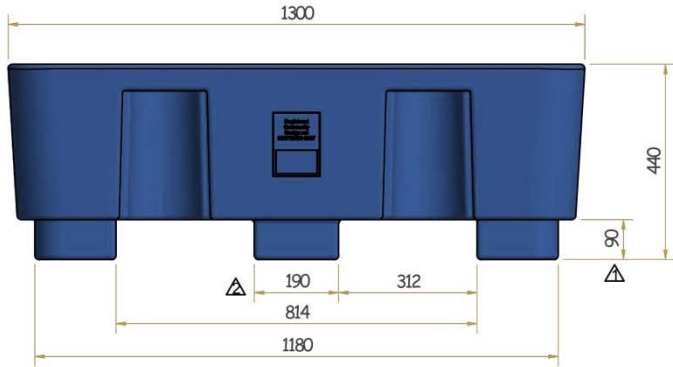

**SJ-100-025 - 5 units per pallet / 5 pièces par palette / 5 Teile pro Palette / 5 piezas por palé**

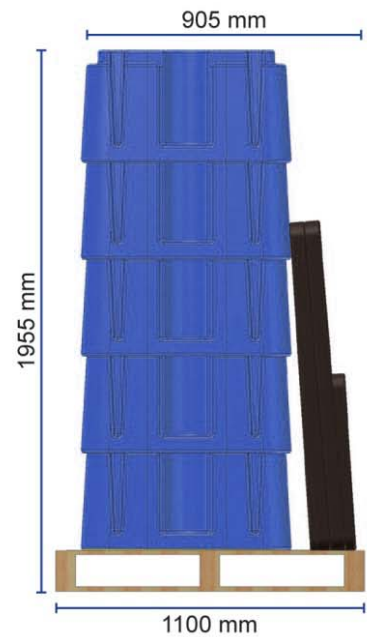
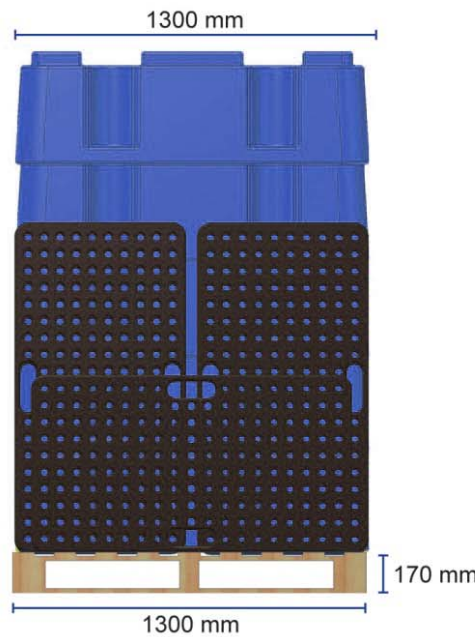

FM12422

**Jonesco (Preston) Ltd.**  
 Pittman Way  
 Fulwood  
 Preston PR2 9ZD  
 England  
 Tel: +44 (0) 1772 704488  
 Fax: +44 (0) 1772 702209

**Jonesco S.A.R.L.**  
 SECLIN UNEXPO  
 1524 Avenue de l'Épinette  
 59113 Seclin  
 France  
 Tel: +33 (0) 3 20 32 1111  
 Fax: +33 (0) 3 20 90 6210  
 SARL au capital de 8,000 euros



www.jonesco-plastics.com