



Technical Data / Fiche Technique / Technische Daten / Datos Técnicos

Document Holders ■ Porte-Documents ■ Dokumentenbehälter ■ Portadocumentos

1008 SERIES / SÉRIE "1008" / 1008ER-REIHE / SERIE 1008



1008







Features/Caractéristiques/Merkmale/Características

Designed to store documents next to machinery (Maintenance checks, manuals, etc) • Ideal for commercial vehicles, containers, forklifts, hire equipment, agricultural applications etc.. • Made from recyclable, chemical resistant polypropylene (PP) • Highly flexible and stress resistant • Fits A4 manuals and US letter size • Standard colour is Black.

als Behälter für maschinenrelevante Daten (Wartung, Bedienanleitungen, etc.) entwickelt • für Nutzfahrzeuge, Container, Gabelstapler, Mietgeräte, etc. geeignet • aus recycelbarem, chemikalienbeständigem Polypropylen (PP) • äußerst flexibel und spannungsresistent • für A4- sowie US-Letter-Format geeignet • Standardfarbe ist schwarz.

Conçus pour le rangement de documents à proximité de machines (fiches d'entretien, manuels, etc.) • Idéaux pour véhicules industriels, conteneurs, chariots élévateurs, équipement de location, applications agricoles etc. • En polypropylène (PP) recyclable et résistant à la plupart des produits chimiques • Hautement flexible et résistant à la tension • Convient aux manuels format A4 et US letter • Couleur noire standard.

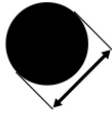
Diseñado para guardar documentos cerca de maquinaria (detalles de inspecciones, libros de instrucciones etcétera) • Idóneo para vehículos comerciales, contenedores, carretillas elevadoras, maquinaria de alquiler, la industria agrícola etcétera • Fabricada de polipropileno (PP) que es reciclable y resistente a la mayoría de los químicos • Muy flexible y resistente a la fatiga • Apto para manuales A4 y papeles en formato EE UU • Color negro como estándar.

	 mm	 mm	 mm	 mm	 mm	Documents Dokumente Documentos	
1008	350	400	115	85	100	A4/US letter	0.4



FM12422

Jonesco (Preston) Ltd.
Pittman Way
Fulwood
Preston PR2 9ZD
England
Tel: +44 (0) 1772 704488
Fax: +44 (0) 1772 702209

Jonesco S.A.R.L.
SECLIN UNEXPO
1524 Avenue de l'Épinette
59113 Seclin
France
Tel: +33 (0) 3 20 32 1111
Fax: +33 (0) 3 20 90 6210
SARL au capital de 8,000 euros



www.jonesco-plastics.com



Technical Data / Fiche Technique / Technische Daten / Datos Técnicos

Document Holders ■ Porte-Documents ■ Dokumentenbehälter ■ Portadocumentos

1008 SERIES / SÉRIE "1008" / 1008ER-REIHE / SERIE 1008



The lid is connected to the body by a small length of chain.

Le couvercle est relié au corps du porte-documents par une chaînette.

Deckel durch Sicherungskette mit dem Körper verbunden.

La tapa está unida a la caja por una cadenita.

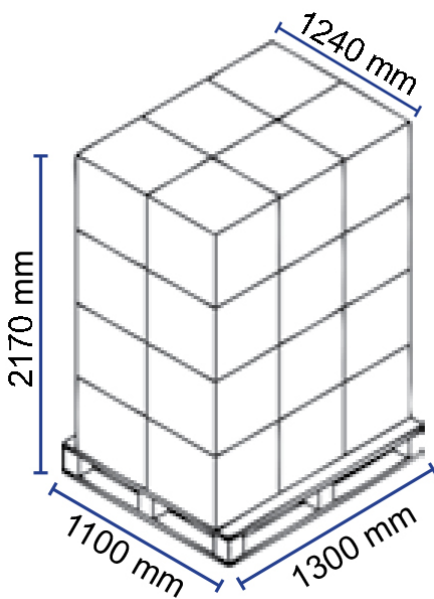

PALLETISATION / PALETTISATION PALETTIERUNG / PALETIZACIÓN

720 units per pallet
720 pièces par palette
720 Teile pro Palette
720 piezas por palé



FM12422

Jonesco (Preston) Ltd.
Pittman Way
Fulwood
Preston PR2 9ZD
England
Tel: +44 (0) 1772 704488
Fax: +44 (0) 1772 702209

Jonesco S.A.R.L.
SECLIN UNEXPO
1524 Avenue de l'Épinette
59113 Seclin
France
Tel: +33 (0) 3 20 32 1111
Fax: +33 (0) 3 20 90 6210
SARL au capital de 8,000 euros



www.jonesco-plastics.com