



JONESCO

HEAVY DUTY SPILL PALLET

PALETTE DE RETENTION CHARGES LOURDES /
SCHWERLAST-AUFFANGWANNE / CUBETO DE RETENCIÓN DE
SERVICIO PESADO





Spill pallet for 2 drums ■ Heavy duty spill pallet (36.5 kg) for substantial loads ■ Designed to take uniformly distributed load of 2000 kg ■ Blue as standard ■ Durable, removable platform ■ Platform with hand inserts and holes for inspection & pump insertion ■ Capacity meets/exceeds European, UK and US regulations ■ For static spill containment ■ Remove drum before fork lifting ■ Compatible with most forklifts and pallet trucks ■ Fully recyclable, chemical resistant, UV-stabilised PE.



Palette de rétention pour stocker 2 fûts ■ Palette de rétention renforcée (36.5kg) spéciale charges lourdes ■ Conçue pour supporter uniformément une charge de 2000 kgs ■ Couleur standard bleue ■ Plate-forme amovible durable ■ Caillebotis avec regards d'inspection et ouvertures pour mains et pompes ■ Capacité conforme ou supérieure aux réglementations Européennes, GB & US ■ Usage statique uniquement ■ Retirer le(s) fût avant manutention ■ Manipulable avec la plupart des chariots élévateurs et transpalettes ■ PE entièrement recyclable, résistant à la plupart des produits chimiques et aux UV.









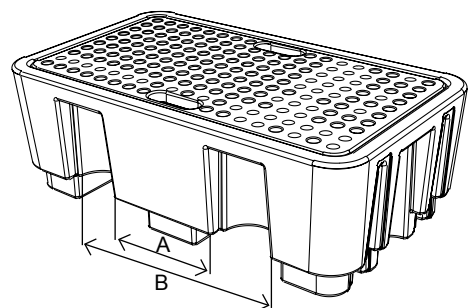

Auffangwanne für 2 Fässer ■ robuste Auffangwanne (36.5 kg) für schwere Lasten ■ für gleichmäßig verteilte Last von 2000 kg ausgelegt ■ Standardfarbe: Blau ■ stabile, abnehmbare PE-Lochplatte ■ Lochplatte mit Kontrollöffnungen & Aussparungen für Pumpen/Handhabung ■ Auffangvolumen erfüllt/übertrifft europäische, britische und US-Vorschriften ■ für den stationären Gebrauch ■ vor Transport mit Stapler Fässer entfernen ■ für die meisten Stapler/Handhubwagen geeignet ■ vollständig recycelbares, chemikalienbeständiges, UV-stabiles MDPE.

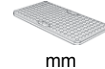

Palet de derrames para 2 bidones ■ Cubeto de retención (36,5 kgs) para cargas pesadas ■ Diseñado para una carga uniformemente distribuida de 2,000 kgs ■ Color azul como estándar ■ Con rejilla extraíble robusta ■ Plataforma con acceso para los manos y agujeros para inspección y para la inserción de bombas ■ Capacidad en línea o por encima de las normas Europeas, Británicas y Americanas ■ Ideales para carga estática ■ Quite los bidones antes de utilizar una carretilla elevadora ■ Para usar con la mayoría de carretillas elevadoras y transpaletas ■ PE 100% reciclable resistente a los rayos UV.



	 mm	 mm	 mm	 kg		 mm				A/B mm	 kg
SJ-100-025	440	1300	750	36.5		630 x 1180 x 55		250	2	190 / 815	2000