

64 Series





Série "64"

64er-Reihe

For extinguishers up to 170 mm dia • Truck & trailer mounting • Internal strap to secure cylinder • Moulded-in fixing points for ease of fitment • Double-skinned lid with waterproof seal • Plastic toggle, lynch pin and hinge pins as standard • Textured surface finish • Optional extra: Kit 65 for vehicle mounting (30° or 60°).

Pour extincteur de diamètre inférieur à 170 mm • Montage possible sur camion et remorque • Ressort de blocage de l'extincteur dans la boîte • Points de fixations moulés facilitant le montage • Couvercle double paroi avec joint étanche • Goupille de sécurité, charnières et fermetures en plastique avec chaque coffre • Etat de surface grené • Option: Kit 65 permettant la fixation à 30° ou 60°.

für Löscher bis 170 mm ø • LKW- oder Hängermontage • Innen-Federband zur Fixierung des Löschers • eingesinterte Montagehilfen für problemlosen Anbau • doppelwandiger Deckel mit Neoprendichtung • Verschlussbügel, Klappsplint und Scharniere aus Kunststoff • strukturierte Oberfläche • Extra: Kit 65 für Montagewinkel 30° oder 60°.

 mm	 mm	 mm	 mm	Ø max mm
640	250	250	590 max	170 max

65 Series





Série "65"



65er-Reihe

Strong durable design & lightweight • Truck & trailer mounting • Internal tension strap helps prevent movement by the cylinder • Plastic toggle, lynch pin and hinge pins as standard • Flat back for ease of mounting • Optional extras: Colours.

Chargement par le dessus • Structure renforcée et légère • Montage possible sur camion et remorque • Ressort de blocage de l'extincteur dans la boîte • Goupille de sécurité, charnières et fermetures en plastique avec chaque coffre • Surface de fixation plane pour faciliter le montage • En option: coloris.

leichte, robuste Ausführung • für LKW- oder Hängermontage • Innen-Federband zur Fixierung des Löschers • Verschlussbügel, Klappsplint und Scharniere aus Kunststoff • Montage-erleichterung durch flache Rückseite • Extras: Sonderfarben.

 mm	 mm	 mm	 mm	Ø max mm
650	260	275	600 max	180 max

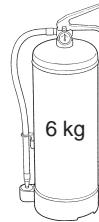

Type	
JBFB64	
JBFR64	

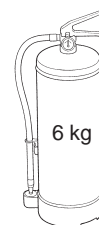

JBFR64



JBFR65

Type	
JBFB65	
JBFR65	

75 Series

Série "75"

75er-Reihe

As 65 Series.

Comme la Série "65".

Wie 65er-Reihe.

Type	
JBFB75	
JBFR75	

mm	mm	mm	mm	Ø max mm
750	300	300	600+	230 max



JBFR75

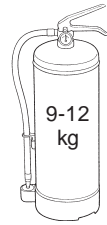

SAFETY BOXES

EQUIPEMENT DE SECURITE

SICHERHEITSKÄSTEN

64/65/75 Series

Also available as Safety Boxes - see relevant description for information, noting that Safety Boxes come without any restraints/straps.

Séries 64/65/75

Sont aussi disponibles en version coffres pour équipements de sécurité. cf. descriptif pour information, noter toutefois que ces coffres sécurité ne comprennent pas de sangle de maintien.

64er/65er/75er-Reihe

auch als Sicherheitskästen erhältlich. Wie vor jedoch ohne Haltebänder.

Type	
JBFA64	
JBFA65	
JBFA75	



JBFA65 & JBFA75

MILITARY BOXES

COFFRE A USAGE MILITAIRE

MILITÄRKÄSTEN

NATO approved and specified for 5 years-Contract A314062/B • Boxes available in NATO green • Independently drop and vibration tested (-35°C) • Strong and durable enough for military use.

Référence OTAN pour 5 ans-Contrat No A314062/B. • Coffres disponibles dans colori vert OTAN • Tests d'impact et de vibration (-35°C) • Grande longévité et résistant même pour un usage militaire.

NATO-Abnahme, Liefervertrag für 5 Jahre-Auftragsnr. A314062/B • erhältlich in NATO-Oliv • unabhängiger Aufprall- und Vibrationstest (-35°C) • robust und stoßfest, ideal für den Militäreinsatz.



JBFM65K

Type		NATO. No Référence OTAN NATO-Nr.	
JBFM65K	KIT55	6MT1/2540-99-0751-9118	
JBFR65K	KIT55	6MT1/2540-99-987-5386	

DIMENSIONS MAÛE

64 Series

Série "64"

64er-Reihe

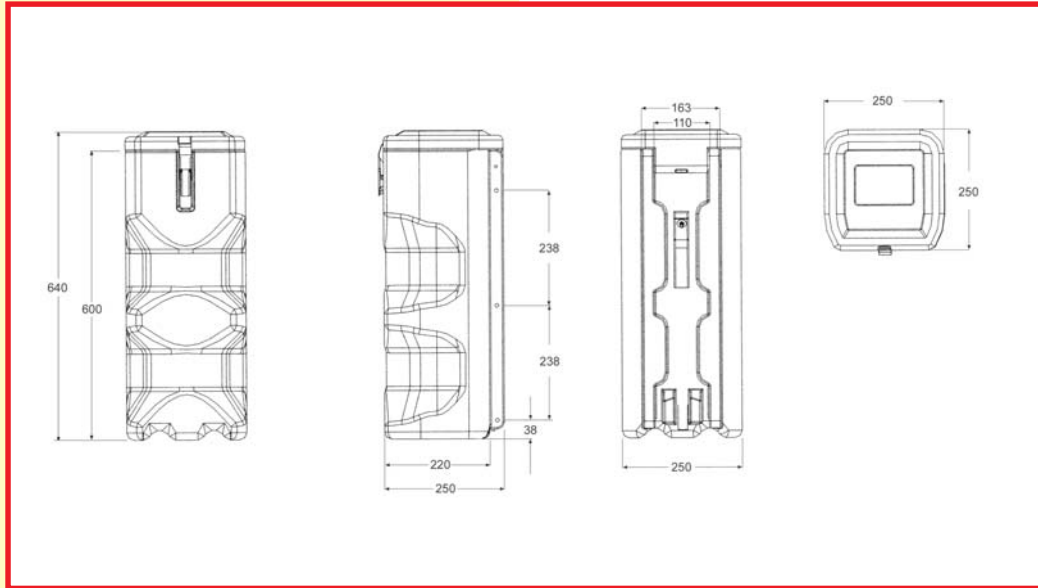

NOTE

ATTENTION

ACHTUNG

When fitting horizontally the boxes should be mounted so that the extinguisher does not rest on top of the tension strap.

En cas de montage horizontal, les coffres doivent être montés de tel façon que l'extincteur ne repose pas sur le ressort de blocage.

Bei waagerechtem Anbau die Kästen so montieren, daß der Feuerlöscher nicht auf dem Federband aufliegt.

Placement of the fire extinguisher label.
Positionnement de l'étiquette <Extincteur>
Feuerlöscher-Piktogramm

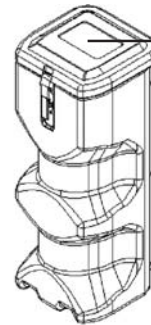

Fit fire extinguisher label here.
Mettez l'étiquette ici.
Aufkleber hier anbringen.

DIMENSIONS

MAÛE

65-75 Series

Série "65-75"

65/75er-Reihe

Type	A mm	B mm	C mm	D mm	E mm	F mm	G mm
JBFR65	240	240	650	70	500	85	45
JBFR75	300	270	750	115	500	130	100

